

Article number: 20113051

Description: E+G

Side thrust pin GN 713-6-75-19-SB

Measures

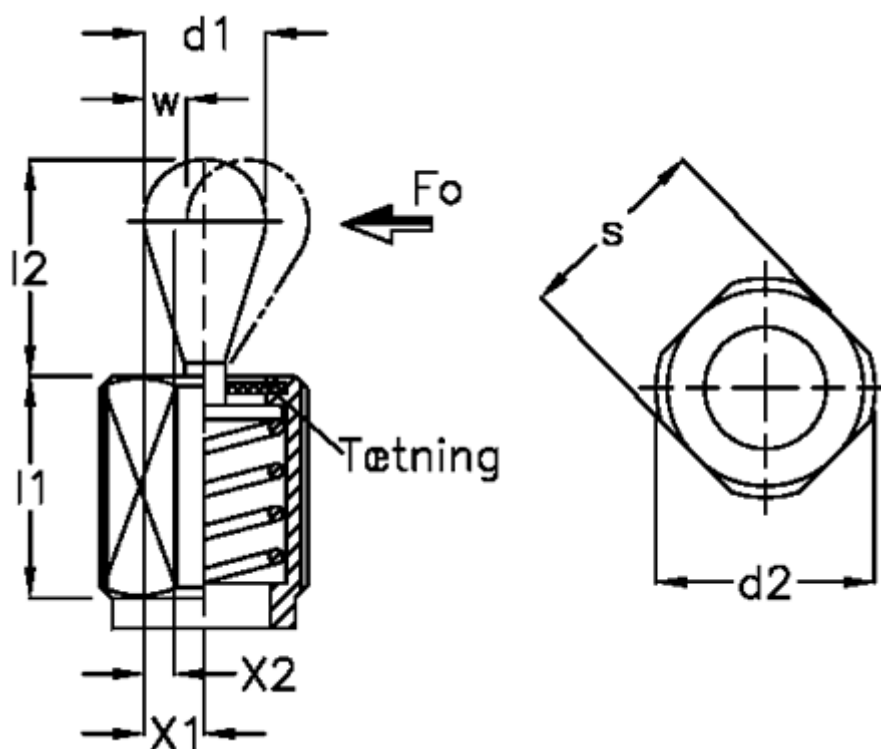

a1 = 3.0

a2 = 7.7

d1 = 6

d2 = M12

K = 1,5x45 degrees

l1 = 19.0

l2 = 10.7

l3 = 10

s = 3

screw driver = GN 713.1-5,6

Side power N at l2 = 75

W = 1.8

x1 = 1.9

x2 = 1.4